



## **User's Manual**

**CPS3500PIE/CPS3500PRO/CPS3500STD  
CPS5000PIE/CPS5000PRO/CPS5000STD**

### **CyberPower North America**

CyberPower Systems (USA), Inc.

4241 12th Avenue East Suite 400 Shakopee, MN 55379

Tel: 877-297-6937

Fax: 952-403-0009

Website: <http://www.cyberpowersystems.com>

E-mail: [sales@cyberpowersystems.com](mailto:sales@cyberpowersystems.com)

### **CyberPower Europe**

CyberPower Systems B.V.

Flight Forum 3545,5657DW Eindhoven, The Netherlands

Tel: +31 (0)40 2348170

Fax: +31 (0)40 2340314

Website: <http://eu.cyberpowersystems.com/>

E-mail: [sales@cyberpower-eu.com](mailto:sales@cyberpower-eu.com)

# Content

<b>SAFETY AND EMC INSTRUCTION.....</b>	<b>2</b>
<b>INSTALLING YOUR EPS.....</b>	<b>4</b>
UNPACKING .....	4
AUTOMATIC VOLTAGE REGULATOR .....	4
HARDWARE INSTALLATION GUIDE .....	4
DESCRIPTION .....	5
INSTALLATION GUIDE.....	7
<b>REPLACING THE BATTERY .....</b>	<b>9</b>
<b>DEFINITIONS FOR ILLUMINATED LCD.....</b>	<b>10</b>
<b>EPS STATUS INQUIRY AND FUNCTIONS SETUP.....</b>	<b>11</b>
1. GENERAL MODE.....	11
2. SET-UP MODE.....	11
<b>FAULT WARNING DISPLAY AND ALARM .....</b>	<b>13</b>
<b>TROUBLE SHOOTING .....</b>	<b>14</b>
<b>TECHNICAL SPECIFICATIONS .....</b>	<b>15</b>

### SAFETY AND EMC INSTRUCTIONS

This manual contains important safety instructions. Please read and follow all instructions carefully during installation and operation of the unit. Read this manual thoroughly before attempting to unpack, install, or operate your Emergency Power System (EPS).

**CAUTION!** To prevent the risk of fire or electric shock, install in a temperature and humidity controlled indoor area free of conductive contaminants. (Please see specifications for acceptable temperature and humidity range).

**CAUTION!** To reduce the risk of electric shock, do not remove the cover.

**CAUTION!** EPS must be connected to an AC power outlet with circuit breaker protection. Do not plug into an outlet that is not grounded. If you need to de-energize this equipment, turn off and unplug the unit.

**CAUTION!** To avoid electrical shock, turn off the unit and unplug it from the AC power source before servicing EPS, replacing the external battery or installing equipment.

**CAUTION!** To reduce the risk of fire, only connect the EPS to a circuit with 40 amperes (CPS3500PIE/CPS3500PRO/CPS3500STD & CPS5000PIE/CPS5000PRO/CPS5000STD Series) maximum branch circuit over-current protection in accordance with the CE requirement.

CPS3500PIE Series include CPS3500PIE、CPS3500PIE-FR、CPS3500PIE-UK and other versions.

CPS3500PRO Series include CPS3500PRO、CPS3500PRO-FR、CPS3500PRO-UK and other versions.

CPS3500STD Series include CPS3500STD、CPS3500STD-FR、CPS3500STD-UK and other versions.

CPS5000PIE Series include CPS5000PIE、CPS5000PIE-FR、CPS5000PIE-UK and other versions

CPS5000PRO Series include CPS5000PRO、CPS5000PRO-FR、CPS5000PRO-UK and other versions

CPS5000STD Series include CPS5000STD、CPS5000STD-FR、CPS5000STD-UK and other versions

**CAUTION!** The building wiring socket outlet (shockproof socket outlet) must be easily accessible and close to the EPS.

**CAUTION!** Please use only VDE-tested, CE-marked mains cable (e.g. the mains cable of your equipment) to connect the EPS to the building wiring socket outlet (shockproof socket outlet).

**CAUTION!** Please use only VDE-tested, CE-marked power cables to connect the loads to the EPS.

**CAUTION!** When installing the equipment, ensure that the sum of the leakage current of the EPS and the connected equipment does not exceed 3.5mA.

**CAUTION!** This is permanently connected equipment and only qualified maintenance personnel may carry out installations.

**CAUTION!** Do not disconnect the mains cable on the EPS or the building wiring socket outlet (shockproof socket outlet) during operations since this would remove the protective ground of the EPS and of all connected loads.

**CAUTION!** THE EPS shall be connected to the emergency switching device.

**DO NOT USE FOR MEDICAL OR LIFE SUPPORT EQUIPMENT!**

DO NOT use in any circumstance that would affect operation or safety of any life support equipment or with any medical applications or patient care.

**DO NOT USE WITH OR NEAR AQUARIUMS!** To reduce the risk of fire or electric shock, do not use with or near an aquarium. Condensation from the aquarium can cause the unit to short out.

**DO NOT USE WITH LASER PRINTERS!** The power demands of these devices will overload and possibly damage the unit.

**DO NOT INSTALL THE EPS WHERE IT WOULD BE EXPOSED TO DIRECT SUNLIGHT OR NEAR HEAT!**

**DO NOT BLOCK OFF VENTILATION OPENINGS IN THE EPS'S HOUSING!**

**DO NOT CONNECT DOMESTIC APPLIANCES SUCH AS HAIR DRYERS TO EPS OUTPUT SOCKETS.**

**SAFETY:**

EN62040-1-1

**EMI:**

Conducted Emission: IEC/EN 62040-2...Category C2

Radiated Emission: IEC/EN 62040-2.....Category C2

Harmonic Current: IEC/EN61000-3-2

Voltage Fluctuations and Flicker: IEC/EN61000-3-3

**EMS:**

IEC/EN61000-4-2(ESD)

IEC/EN61000-4-3(RS)

IEC/EN61000-4-4(EFT)

IEC/EN61000-4-5(lightning surge)

IEC/EN61000-4-6(CS)

IEC/EN61000-4-8(Magnetic)

IEC/EN61000-2-2 (Immunity to low frequency signals)

## INSTALLING YOUR EPS

### **UNPACKING**

Inspect the EPS upon receipt. The box should contain the following:

EPS unit x1; Installation Guide x1; User manual x1; Battery Wiring Arrangement manual x 1;

### **AUTOMATIC VOLTAGE REGULATOR**

When utility power is inconsistent, the EPS would increase low voltage or decrease high voltage to safe 220 volts. The EPS automatically provides battery backup (External battery connection required) if the voltage drops below 140 volts or exceeds 300 volts.

### **HARDWARE INSTALLATION GUIDE**

1. Your new EPS may be used immediately upon receipt. However, recharging the external battery for at least 8 hours is recommended to ensure that the battery's maximum charge capacity is achieved (Charging time varies with capacity and a 100Ah or greater battery is recommended). To recharge the external battery, simply leave the unit plugged into an AC outlet. Your EPS is equipped with an auto-charge feature. When the EPS is plugged into an AC outlet, the external battery will automatically recharge. The unit will charge in both the ON and OFF positions.
2. **DO NOT plug a laser printer, paper shredder, copier, space heater, vacuum or other large electrical device into the EPS. The power demand of these devices may overload and damage the unit. DO NOT use with medical or life support equipment. DO NOT use with or near aquariums as condensation may cause the unit to short.**
3. After connecting the hard wires, plug the EPS into a 2 pole, 3 wire grounded receptacle (wall outlet). Make sure the wall branch outlet is protected by a fuse or circuit breaker and does not service equipment with large electrical demands (e.g. refrigerator, copier, etc...). The warranty prohibits the use of extension cords, outlet strips, and surge strips.
4. Press the power switch to turn the unit on. The power on indicator light will illuminate and the unit will beep once.
5. If an overload is detected, an audible alarm will sound and the unit will emit one long beep. To correct this, turn the EPS off and unplug at least one piece of equipment from the battery power supplied outlets. Wait 10 seconds. Make sure the circuit breaker is depressed and then turn the EPS on.
6. To maintain optimum battery charge performance, make the EPS plugged into an AC outlet at all times. Enabling the switch provides the bypass for charge only.

## BASIC OPERATION

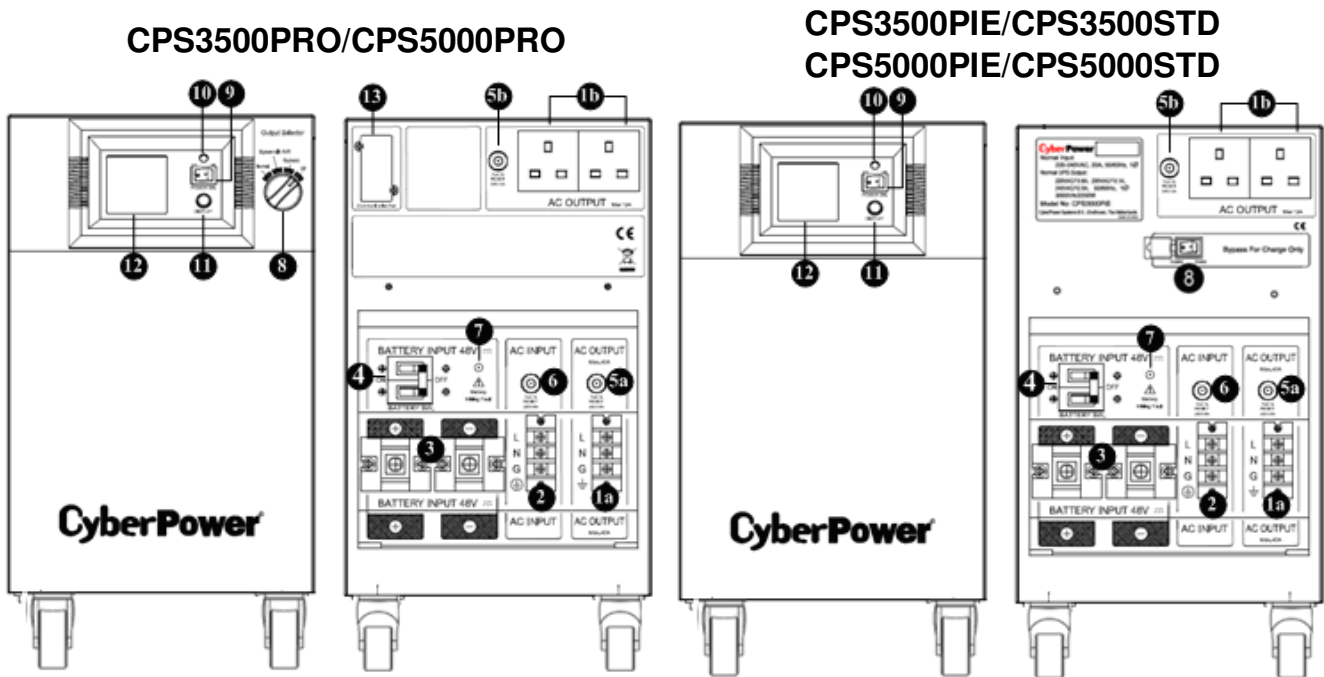

\* STD Series only use soft pad

### DESCRIPTION

#### 1. AC Outlets

EPS PRO/PIE Series have two general plug-in outlets (UK/Schuko/ France) and one terminal outlet for connected equipment which ensures temporary uninterrupted operation of the equipment during a power failure. Max. Output of 1a is 40A ; Max. Output of 1b is 12A for UK socket, 16A for Schuko/France socket. Max. Output wattage of (1a+1b) is 2450W (CPS3500PIE/CPS3500PRO/CPS3500STD Series)/ 3500W (CPS5000PIE /CPS5000PRO/CPS5000STD Series).

\***Note:** Maximum cord length is 10 meters and the cable O.D. must be 10AWG (CPS3500PIE/CPS3500PRO/CPS3500STD & CPS5000PIE/CPS5000PRO/CPS5000STD Series) or greater.

#### 2. AC Inlet

AC input terminals

\***Note :** The O.D. of the distribution cables must be 10AWG (CPS3500PIE/CPS3500PRO/CPS3500STD & CPS5000PIE/CPS5000PRO/CPS5000STD) or greater.

#### 3. DC Inlet

Battery input terminals

\***Note :** Maximum battery wiring cable length is 2 meters and the cable O.D. must be 4AWG or greater.

#### 4. DC Circuit Breaker

Located on the side of the EPS, the circuit breaker serves to provide overload and fault protection.

#### 5. AC Output Circuit Breaker

Located on the side of the EPS, the circuit breaker serves to provide overload and fault protection.

**\*Note:** Circuit breaker 5a provides max 40A protection for 1a socket.

**\*Note:** Circuit breaker 5b provides max 12A protection for UK socket or 16A for Schuko and France socket.

### 6. AC Input Circuit Breaker

Located on the side of the EPS, the circuit breaker serves to provide overload and fault protection.

### 7. Battery Input Wiring Fault LED

Battery input wiring fault LED will illuminate and make an audible alarm to indicate the wiring polarity is reversed.

### 8. Output Selector

Output Selector provides four most common operation situations for switch include Normal, Bypass with AVR, Bypass, Off. No matter under what situations, the charger would keep charging external batteries if utility power is still alive.

Normal :The unit will provide all functions of uninterruptible power supply include charger.

Bypass with AVR: The unit will bypass the utility power with voltage regulator and shutdown the unit when the utility power exceed 300Vac or below 140Vac.

Bypass: The unit will bypass the utility power to output directly.

**\*Note:** Bypass model wouldn' t provide any overvoltage protection .Utility power may damage equipments plugged to EPS, make sure equipment safe before switch to this model.

Off: The unit will interrupt all outlets power output.

**\*Note:** The charger would still work under these four switch modes.

**\*For PIE and STD Series, the unit provides specific Bypass function.**

Bypass: The switch provides the bypass for charge only and shutdown the unit when the utility power exceeds 300Vac or below 140Vac. In charger only mode, AVR and battery backup will not work.

### 9. Power Switch

Used as the master on/off switch for equipment connected to the battery power supplied outlets.

### 10. Power On Indicator

This LED is above the power switch. It illuminates when the utility condition is normal and the EPS outlets are providing power, free of surges and spikes.

### 11. LCD Display Toggle / Selected Switch

Users can monitor EPS status and set up functions using the toggle.

### 12. Multifunction LCD Readout

High resolution and intelligent LCD display shows all the EPS information with icons and messages. For more information please check the DEFINITIONS FOR ILLUMINATED LCD INDICATORS section.

### 13. SNMP/DB9/USB Network slot

Remove the cover panel to install optional SNMP/DB9/USB CARD that allows remote monitoring and control of your UPS through network or cable.

**\* Note:** This function only provide on PRO Series.

**INSTALLATION GUIDE**

Note: The installation must be done by professionals.

1. Remove the cover from the back of the machine.
2. Make sure the POWER SW, Output Selector, and the BATTERY SW. are turned off. (Step1)

**Step 1**

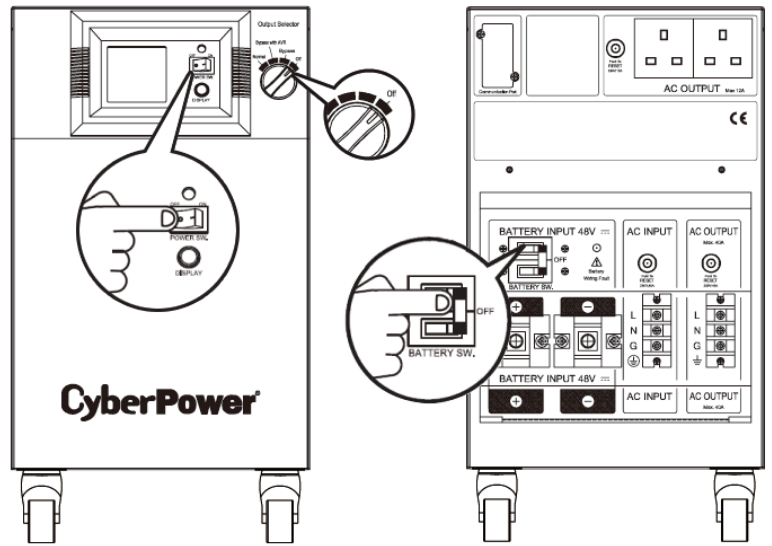

EPS will not function if the Output Selector is OFF. Make sure the Selector on Normal position after all installation procedures.

**Step 2**

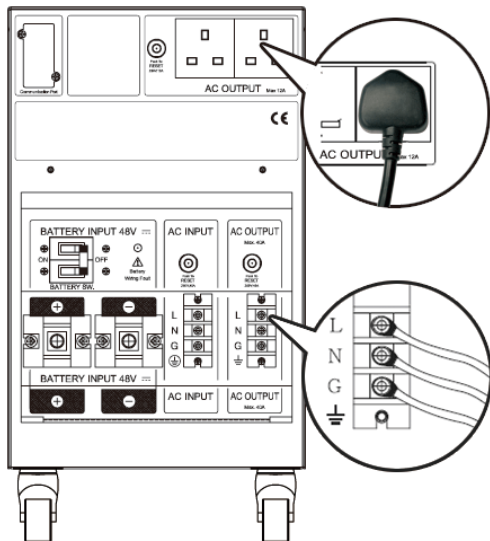

**Step 3**

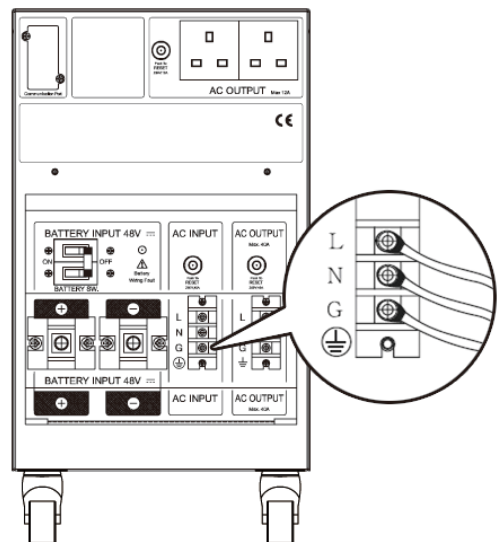

3. Connect the AC OUTPUT connections (AC plugs or terminal connections). (Step2)
4. Connect the AC power source to AC INPUT (Make sure AC power is off first). (Step3)



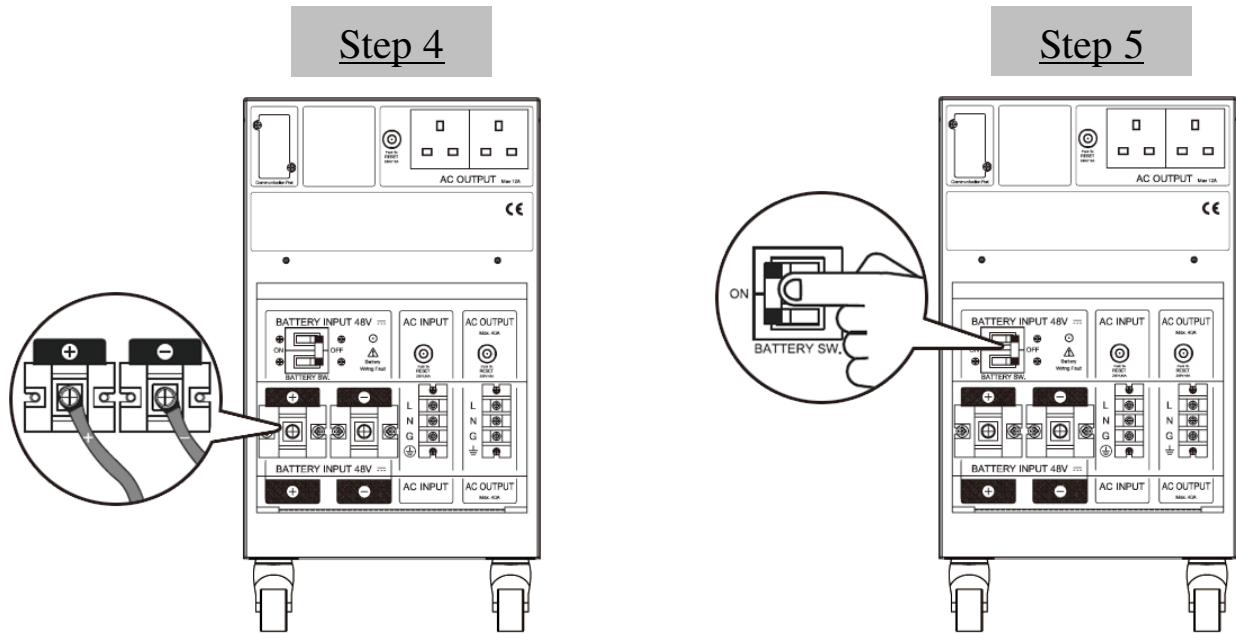

5. Connect the batteries to the BATTERY INPUT. (Step4)



WIRING FAULT LED will illuminate and make an audible alarm to indicate the wiring polarity is reversed.

6. If the battery box or the battery connection has a switch, please turn it on first.

7. Turn on the BATTERY SW. on the back of the machine (Step 5)

8. Turn on the Power Switch and switch the Output Selector to Normal on the front panel. The Power On Indicator and the LCD Module Display will blink 4 times. Press the Display toggle (Selected Switch) once. The output voltage showing on the LCD Module Display should be 220V. This completes the start-up process. (Step 6)

9. Press and hold the Display toggle switch for 4 seconds then release. The machine will begin a self test and enter Battery Mode for 6 seconds before returning to Line Mode. Make sure the self test is ready, or see the Definitions for illuminated LCD on page 10 for a list of alarm code definitions.

10. After ensuring the machine works normally, reassemble the back cover. The installation is now complete.

11. When the external battery needs to be maintained or replaced remember to turn the machine off. Once off, remove the AC power source and switch off the BATTERY SW. before maintenance or replacing the batteries. When the work is complete, please start from Step 1 to re-install the machine.

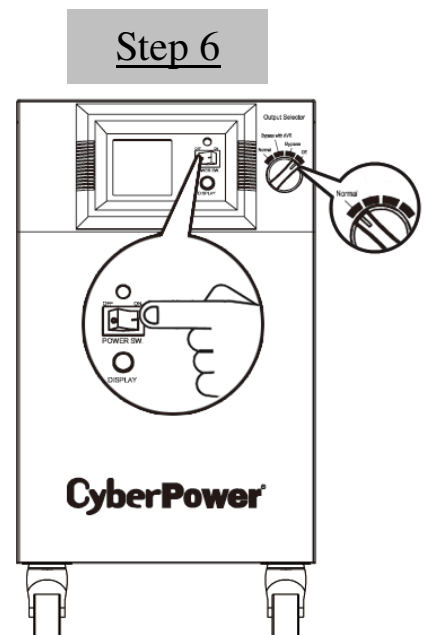

## REPLACING THE BATTERY

**CAUTION!** Read and follow the IMPORTANT SAFETY INSTRUCTIONS before servicing the battery. Battery service should only be done by qualified professionals.

**CAUTION!** Use only the specified type and number of external batteries. Please see the technical specifications for replacement batteries.

**CAUTION!** The battery may present a risk of electrical shock. Do not dispose of battery in a fire as it may explode. Follow all local ordinances regarding proper disposal of batteries. Lead-acid batteries should be recycled.

**CAUTION!** Do not open or mutilate the batteries. Released electrolyte is harmful to skin and eyes and may be toxic.

**CAUTION!** The external battery cabinet must be provided with 100A x2/ 80V for models CPS3500PIE , CPS3500PRO,CPS3500STD,CPS5000PIE, CPS5000PRO and CPS5000STD of DC protective device.

CPS3500PIE Series include CPS3500PIE 、CPS3500PIE-FR 、CPS3500PIE-UK and other versions.

CPS3500PRO Series include CPS3500PRO 、CPS3500PRO-FR 、CPS3500PRO-UK and other versions.

CPS3500STD Series include CPS3500STD 、CPS3500STD-FR 、CPS3500STD-UK and other versions.

CPS5000PIE Series include CPS5000PIE 、CPS5000PIE-FR 、CPS5000PIE-UK and other versions

CPS5000PRO Series include CPS5000PRO 、CPS5000PRO-FR 、CPS5000PRO-UK and other versions

CPS5000STD Series include CPS5000STD 、CPS5000STD-FR 、CPS5000STD-UK and other versions

**CAUTION!** A battery can present a high risk of short circuit current and electrical shock.

Take the following precautions before replacing the battery:

1. Remove all watches, rings or other metal objects.
2. Only use tools with insulated handles.
3. Do not lay tools or metal parts on top of battery or any terminals.
4. Wear rubber gloves and boots.
5. Determine if the external battery is inadvertently grounded. If grounded, remove the source of ground. **CONTACT WITH GROUNDED BATTERY CAN RESULT IN ELECTRICAL SHOCK!**

## DEFINITIONS FOR ILLUMINATED LCD

The LCD Display indicates a variety of EPS operational conditions. All descriptions apply when the EPS is plugged into an AC outlet and turned on or when the EPS is on battery.

**1. INPUT VOLTAGE Meter:** This meter measures the AC voltage that the EPS is receiving from the utility wall outlet. The EPS is designed, through the use of automatic voltage regulation, to continuously supply connected equipment with stable, 220 output voltages. In the event of a complete power loss, severe brownout or over-voltage the EPS will rely on its external battery to supply consistent 220 output voltage. The Input Voltage Meter can be used as a diagnostic tool to identify poor quality input power.

**2. OUTPUT VOLTAGE Meter:** This meter measures, the AC voltage that the EPS is providing to the equipments. It displays normal line mode, AVR mode, and battery backup mode.

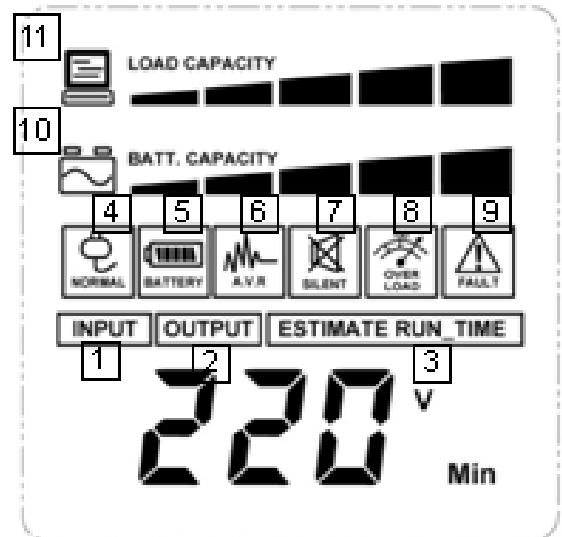

**3. ESTIMATE RUN TIME:** This displays the run time estimate of the EPS. Once the run time becomes shorter and the current battery capacity would decrease. (You can see the BATT. Bar chart keeps falling)

**Note!** This function of specified models cannot work.

**4. NORMAL MODE Icon:** This icon will illuminate when the EPS is working under normal conditions.

**5. ON BAT (On Battery) Icon:**

During a severe brownout or blackout, this icon illuminates and an alarm sounds (2 short beeps followed by a pause) to indicate the EPS is operating from its external batteries. During a prolonged brownout or blackout, the alarm will sound continuously. When the BATTERY CAPACITY Meter shows one 20% capacity segment remaining it indicates the EPS's external batteries are nearly out of power. You should save files and shut down your equipment immediately.

**6. AVR (Automatic Voltage Regulator) Icon:** This icon will illuminate whenever your EPS is automatically correcting high or low AC line voltage. This is a normal, automatic operation of your EPS, and no action is required on your part.

**7. SILENT MODE Icon:** This icon illuminates whenever the EPS is in silent mode. The buzzer will not beep during the battery mode until the battery reaches low capacity.

**8. OVER LOAD Icon:** This icon will illuminate and an alarm will sound to indicate the battery supplied outlets are overloaded. To clear the overload, unplug some of your equipment from the battery supplied outlets until the icon is no longer illuminated and the alarm stops.

**9. FAULT MODE Icon:** This icon illuminates if there is a problem with the EPS. Please contact

CyberPower Systems for further help and support.

**10. BATTERY CAPACITY Meter:** This meter displays the approximate charge level (in 20% increments) of the EPS's external battery. During a blackout or severe brownout, the EPS will switch to battery power, the ON BAT icon will be illuminated, and the charge level will decrease.

**11. LOAD CAPACITY Meter:** This meter displays the approximate output load level (in 20% increments) of the EPS's battery outlets.

## EPS Status Inquiry and Functions Setup

### 1. General Mode

a. Press the "Display" button to check the status of the EPS.

Item	Unit
Input Voltage	V
Output Voltage	V
Output Frequency	Hz
Load	Kw
Load Capacity	%
Battery Capacity	%
Centigrade	°C
Fahrenheit	°F

b. Press and hold the **Display** toggle for 4 seconds.

- If the machine is in the Battery Mode, it enters the status of Mute.
- If the machine is in the Line Mode, it proceeds to Self Test.

c. If the **Display** toggle remains untouched for over 30 seconds, the LCD backlight will turn off automatically.

### 2. Set-up Mode

**Step 1:** The machine enters Set-Up Mode after holding the Display toggle for 10 second Icon 4,5,6,7,8,9 lights indicate that Set-Up Mode.

**Step 2:** By pressing the Display toggle, users can switch between setup functions. User configurable functions are as follows:

a. **Delay Time:** The time delay between switching from Battery Mode to Line Mode. There are 9 different settings. The default setting is 2.0 minutes.

**Function description:** The machine will switch from Battery Mode to Line Mode after the AC power transmission reaches stability within the preset delay time.

b. **Battery AH:** The function adjusts the battery charging current according to the capacity of the connected batteries. It can be configured for 50, 100, 150 and 200AH. The default

setting is 200AH.

**Function description:** The charger will automatically adjust current to setting value.

- c. Nominal Output Voltage: Configures the correct electricity/voltage supplied in the area/country where the EPS will be used. 220V, 230V and 240V may be selected. The system default setting is 220V.

**Function description:** AVR Dynamic Voltage Compensation works automatically based on the system voltage settings.

- d. Static Frequency Tolerance: There are 6 settings (1,2,4,6,8,10%), and the default setting is +/-10%.

**Function description:** The settings may be adjusted to the quality of the electricity in use.

- e. Slew Rate (Dynamic Frequency Tolerance): There are 5 different settings (0.25,0.5,1,2,4 Hz/Sec). The default value is 4Hz/sec.

**Function description:** "Slew Rate" indicates the tolerance of a device in accepting frequency variances. The lower "Slew Rate" results in less tolerance but better protection for the connected loads.

- f. Battery Shutdown Voltage: This function adjusts the UPS shutdown point according to the battery voltage. There are 5 settings(38V,39V,40V,41V,42V) and the default setting is 40V.

- g. Mode Select: There are 2 settings( Robust{1},Standard{2} ) ,The robust mode and the standard mode are provided to select. Using the generators is suggested to select the robust mode, and using the computers is suggested to select the standard mode. The default setting is Robust {1}. The settable items are sorted by unit as in the following table :

Items	Unit	Icon Lit
Delay Time	Min	ON BAT
Battery AH	A	ON BAT
Nominal Output Voltage	V	NORMAL MODE
Static Frequency Tolerance	%	NORMAL MODE
Slew Rate	%	None
Battery Shutdown Voltage	V	ON BAT
Mode Select	None	None

**Step 3:** Press and hold the toggle for 4 seconds. When the icons blink, the value of each item can be changed by slightly pressing the toggle.

**Step 4:** To save the value and return to general mode, press and hold the toggle for 4 seconds.



**Note:** If the machine is left idle for over 30 seconds during setup, it will turn off the backlight and return to general mode automatically.

**Note:** If user wants to return to general mode without saving changes, there are two methods:

1. Wait for the backlight to turn off
2. Press and hold the "Display" toggle for 10 seconds

**FAULT WARNING DISPLAY AND ALARM**

1. **Overheat Protection** : The machine shut down and the LCD display output voltage is zero.
2. **Over-Load Protection** : The machine shut down and Over Load and FAULT Icon lights on the LCD display.
3. **Battery Missing** : The machine sounds long and rapid beep and Battery icon flashes.
4. The following table shows each corresponding warning message on the LCD display and the alarm reacts during the machine shut down :

 <b>LCD Warning Display</b>	 <b>Alarm</b>	<b>Condition</b>	<b>Solution</b>
Over Load Icon	Long Beep	Over Load Output-Off - Load exceed the rating of EPS.	Check total load to confirm the rating of EPS.
Battery Icon Flash	Rapid Beep	Battery Missing- In Line Mode Battery Missing.	Turn the EPS off, check battery wiring and presence of battery
Zero Output Voltage	Rapid Beep	High Temperature: Output Off (Over 70°C) Low Battery Output-Off -- Insufficient battery capacity.	Check fans function and air vent clearances. Recharge the battery.
	Recurring Beep	Over Charge or AVR Error-- In Line Mode, battery is overcharged or AVR is faulty.	Inform service agents.
	Long Beep	Short Output-Off -- Output Short Circuit Protection	Check the EPS output to see if there is a short circuit.
Can Not Start Up	None	Line Input/ Output Error Output-Off -- incorrect Input/ Output connection	Check Input/ Output connection.
		Cold Start Battery High Voltage Output-Off -- the battery voltage is too high during cold start.	Check the reason for battery over-voltage.

**TROUBLESHOOTING**

Problem	Possible Cause	Solution
Outlet does not provide power to equipment.	Circuit breaker has tripped due to an overload.	First, turn the EPS off and unplug at least one piece of equipment. Wait 10 seconds, reset the circuit breaker by pressing the button, and then turn the EPS on.
	Batteries are discharged.	Recharge the unit for at least 4 hours.
	Unit has been damaged by a surge or spike.	Contact CyberPower Systems about replacement batteries at <a href="mailto:service@cyberpower-eu.com">service@cyberpower-eu.com</a>
	Uncritical outlets have turned off automatically due to an overload.	Push the toggle button to make the uncritical outlets turn on.
The EPS will not turn on.	The on/off switch is designed to prevent the damage that rapidly turns it off and on.	Turn the EPS off. Wait 10 seconds and then turn the EPS on.
	The unit is not connected to an AC outlet.	The unit must be connected to a 220/230/240v outlet.
	The battery is worn out.	Contact CyberPower Systems about replacement batteries at <a href="mailto:service@cyberpower-eu.com">service@cyberpower-eu.com</a>
	Mechanical problem.	Contact Cyberpower Systems via phone or visit our website at <a href="http://www.cyberpowersystems.com">www.cyberpowersystems.com</a>
Software is inactive to EPS	The serial cable or USB cable is not connected.	Connect the cable to the UPS unit. You must use the cable that came with the unit.
	The cable is connected to the wrong port.	Try another port of your computer.
	The unit is not providing battery power.	Shutdown your computer and turn the EPS off. Wait 10 seconds and turn the EPS back on. This should reset the unit.
	The serial cable is not the cable that was provided with the unit.	You must use the cable included with the unit for the Software.

**TECHNICAL SPECIFICATIONS**

Model	CPS3500PIE CPS3500PRO	CPS3500STD	CPS5000PIE/ CPS5000PRO	CSP5000STD
Capacity (VA)	3500VA	3500VA	5000VA	5000VA
Capacity (Watts)	2450W	2450W	3500W	2450W
Operation Technology	AVR ( Single Boost & Single Buck )			
<b>AC Input</b>				
Input Voltage Range	140Vac – 300Vac			
Input Frequency Range	50/60 Hz +/- 5 Hz (auto sensing)			
<b>AC Output</b>				
Phase	Single Phase			
On Battery Typical Output Voltage	Pure Sine Wave at 220Vac +/- 5%			
Nominal Output Voltage	Configurable for 220 : 230 : 240Vac			
Battery Output Frequency	50 / 60 Hz +/- 1%			
Overload Protection	On Utility: Circuit Breaker On Battery: Internal Current Limiter			
Transfer Time	< 10 ms ( Typical )			
Output Receptacles	UK Type *2 + Terminal Block Note! Schuko * 2 + Terminal Block (for Germany type)			
<b>External Battery</b>				
Voltage x Recommended Rating X Quantity	12V x 200Ah X 2		12V x 200Ah X 4	
External Battery Voltage	24V		48V	
External Battery Type	Sealed Maintenance Free Lead Acid Battery			
External Battery Protection	DC Circuit Breaker			
Hot Swappable	Yes			
Extended Runtime	Yes	NO	Yes	NO
<b>Status Indication</b>				
Indicators	Power On, LCD Display			
Audible Alarms	On Battery, Low Battery, Overload			
<b>Environmental</b>				
Temperature	32°F to 104°F ( 0°C to 40°C )			
Relative Humidity	0 to 95% Non-Condensing			
<b>Physical</b>				
Dimensions (L*W*H)( mm )	330*260*440			
Weight (Kg)	36 Kg	34 Kg	44 Kg	42Kg
<b>Safety</b>				
Certificated	CE/SONCAP			





# CyberPower®

**Reliability. Quality. Value.**

For more information, contact us at:

**CyberPower North America**

CyberPower Systems (USA), Inc.

4241 12th Avenue East Suite 400 Shakopee, MN 55379

Tel: 877-297-6937

Fax: 952-403-0009

Website: <http://www.cyberpowersystems.com>

E-mail: [sales@cyberpowersystems.com](mailto:sales@cyberpowersystems.com)

**CyberPower Europe**

CyberPower Systems B.V.

Flight Forum 3545,5657DW Eindhoven, The Netherlands

Tel: +31 (0)40 2348170

Fax: +31 (0)40 2340314

Website: <http://eu.cyberpowersystems.com/>

E-mail: [sales@cyberpower-eu.com](mailto:sales@cyberpower-eu.com)

Entire contents copyright © 2009 CyberPower Systems, Inc.  
All rights reserved. Reproduction in whole or in part without permission is prohibited.